

ABSOLYTE[®] GX



2000 to 6000 AH

**Performance Specifications for ABSOLYTE[®] GX Batteries
Amperes @ 25°C (77°F) — 1 hour to 120 hours**

**CONSTANT CURRENT
SPECIFICATIONS
High Capacity VRLA Line**

ABSOLYTE[®] GX

State of the Art Design

As an industrial battery ages, chemical corrosion causes the positive plates to expand, placing pressure on the posts, the cover and the seals. Excessive plate growth, which can be caused by high temperature environments, will cause the positive plate to damage the cover and seals, thus shortening the life of the battery. The GX design helps eliminate this failure mode by removing stresses placed on the seals and cover by forcing the growth away from the seal.

- 1 The steel face plate reduces stress on cover, and improves heat dissipation through cover.
- 2 The post restraint spacer reduces stress on post using the face plate for support.
- 3 Plate growth is forced away from the posts and cover seals.
- 4 Additional space to accommodate the positive plate growth.
- 5 Horizontal plate stacking improves heat dissipation through tray.
- 6 High separator compression within the cell maintains plate to separator contact, helping to prevent capacity loss.
- 7 Unique "S" wrap absorbed glass mat separator design helps prevent positive (orange) plate to negative (gray) plate shorting.

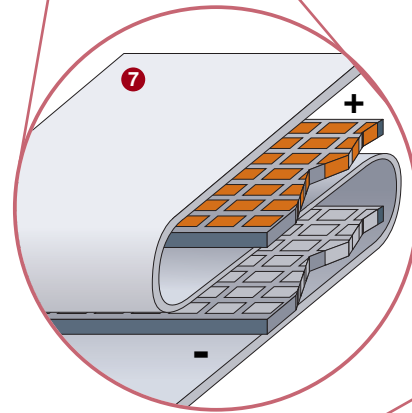
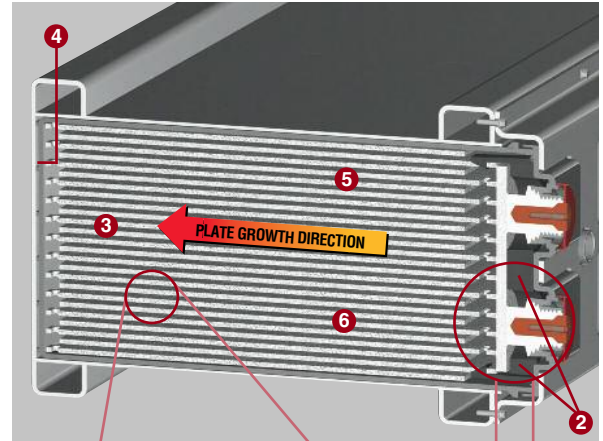

The Most Reliable Post and Jar to Cover Seal Design

- 8 The GX post seal design eliminates the lead to lead bond with a completely non-corrosive polypropylene to polypropylene bond – formed by a fusion process that creates a bond as strong as, or stronger than the original material.
- 9 The interface between the lead post and the plastic sleeve is coated with a viscous bonding agent which guarantees a leak free bond.
- 10 The proven tongue and groove seal technology used on the jar to cover seal improves seal strength and durability.

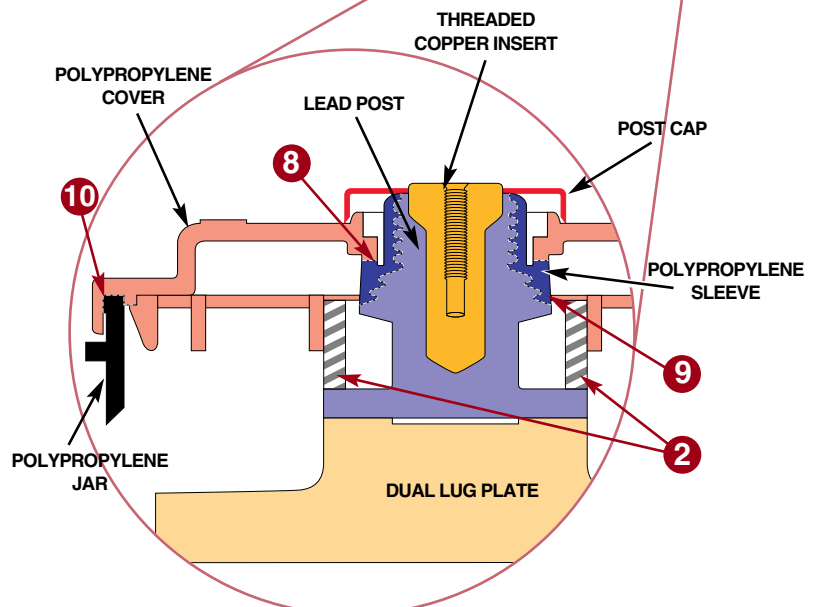

In Plant Helium Leak Testing

Leaks 1000 times smaller than the eye can see are discovered by super-sensitive leak detection system, helping to guarantee the quality of the seals.

ABSOLYTE® GX

Absolyte® GX Quick Specs

System Ampere-hour Range: 2000 to 6000 Ah to 1.75 VPC at 8 hour rate

Container and Cover. Flame Retardant Polypropylene standard (UL94 V-0/28% L.O.I)

Positive Plate: Patented Lead-Calcium-Tin-Silver positive grid

Negative Plate: Lead Calcium grid alloy

Separator: Absorbent glass mat (AGM)

Electrolyte: 1.295 Specific Gravity Acid

Terminals: Solid Copper

Safety Vent: 3-10 psi opening pressure, self resealing

Container to Cover Seal: Polypropylene to polypropylene fusion bond



Post to Cover Seal: Polypropylene to polypropylene fusion bond

Float Voltage: 2.23 to 2.25 VPC

Design Life: 20 years in float service at 25°C (77°F)¹

Cycle Life: 1200 cycles to 80% DOD at 25°C (77°F)¹

Operating Temperature: Temperature excursions between -40°C (-40°F) to +50°C (122°F) allowed (Battery performance and life will be affected)

Seismic Zone 4 Certified:

1994 UBC (At all levels)	1997 UBC (At or below grade)
2-GX2000: 6 high	2-GX2000: 6 high
2-GX3000: 4 high	2-GX3000: 6 high

3-GX2000 Module is certified to 1997 UBC Seismic Zone 4 up to 4-high and Seismic Zone 1 up to 8 high.

Absolyte® GX Module Weights and Dimensions

MODULE TYPE**	VOLTS	NOM AH CAP (8 HR)	STACKING DIMENSIONS						MAXIMUM UNPACKED WEIGHT	
			LENGTH		DEPTH*		HEIGHT		LBS	KG
			IN	MM	IN	MM	IN	MM		
2-GX2000	4	2000	38.09	967	21.36	543	11.46	291	695	315
3-GX2000	6	2000	55.14	1402	21.36	543	11.46	291	1050	477
2-GX3000	4	3000	38.09	967	21.36	543	15.57	396	985	447

* Includes 80 mm (3.15") additional for Module Cover Assembly
 ** 2 Cell Modules are standard for GX2000 and GX3000. 3-cell GX2000 modules are available.
 Note: Design and/or specifications subject to change without notice. If questions arise, contact your local GNB sales representative for clarification.

Horizontal Stack Assembly

- Depth is overall, including module cover assembly.
- Add 102mm (4") for bottom I-beam supports to determine the total height of each assembled horizontal stack.
- Allow 152mm (6") additional clearance wherever a terminal plate assembly is to be located.

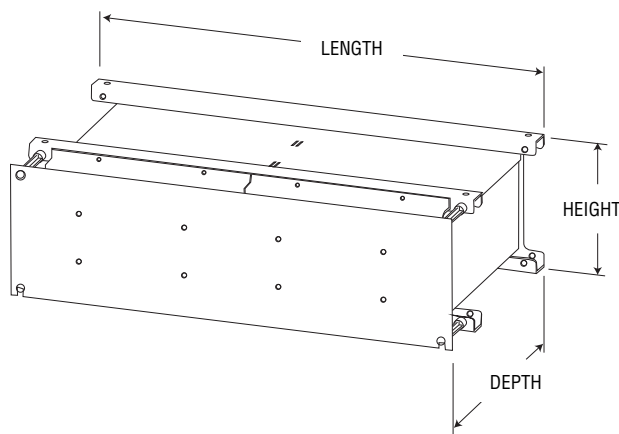

ABSOLYTE[®] GX

Absolyte[®] GX Performance Specifications — Constant Current, 1 hour to 24 hours Amperes to 1.50 Final Volts Per Cell @ 25°C (77°F)

BATTERY TYPE	HOURS											
	24	12	10	9	8	7	6	5	4	3	2	1
GX2000	99	182	212	232	255	284	321	369	438	542	729	1241
GX3000	148	273	318	347	383	426	481	554	656	812	1094	1861
GX4000	198	364	425	463	510	568	642	739	875	1083	1458	2481
GX5000	247	455	531	579	638	710	802	924	1094	1354	1823	3101
GX6000	296	546	637	695	765	852	962	1108	1313	1625	2187	3722

Amperes to 1.60 Final Volts Per Cell @ 25°C (77°F)

BATTERY TYPE	HOURS											
	24	12	10	9	8	7	6	5	4	3	2	1
GX2000	99	182	212	231	254	283	320	369	437	540	726	1223
GX3000	148	272	318	347	382	425	480	553	655	810	1089	1835
GX4000	197	363	424	462	509	567	640	737	873	1081	1453	2447
GX5000	246	454	530	578	636	708	800	922	1092	1351	1816	3059
GX6000	296	545	635	693	763	850	960	1106	1310	1621	2179	3670

Amperes to 1.70 Final Volts Per Cell @ 25°C (77°F)

BATTERY TYPE	HOURS											
	24	12	10	9	8	7	6	5	4	3	2	1
GX2000	98	180	210	229	253	281	318	366	433	536	716	1167
GX3000	146	270	315	344	379	422	477	549	650	803	1074	1750
GX4000	195	360	420	459	505	563	636	732	867	1071	1432	2333
GX5000	244	450	525	573	632	703	795	915	1083	1339	1790	2917
GX6000	293	540	630	688	758	844	954	1098	1300	1607	2148	3500

Amperes to 1.75 Final Volts Per Cell @ 25°C (77°F)

BATTERY TYPE	HOURS											
	24	12	10	9	8	7	6	5	4	3	2	1
GX2000	96	178	208	227	250	278	315	362	429	529	702	1108
GX3000	144	267	312	340	375	418	472	544	643	793	1053	1662
GX4000	193	356	416	454	500	557	629	725	858	1058	1405	2216
GX5000	241	445	520	567	625	696	787	906	1072	1322	1756	2770
GX6000	289	534	624	681	750	835	944	1087	1286	1586	2107	3324

Amperes to 1.78 Final Volts Per Cell @ 25°C (77°F)

BATTERY TYPE	HOURS											
	24	12	10	9	8	7	6	5	4	3	2	1
GX2000	95	176	206	224	247	275	311	358	423	521	687	1060
GX3000	143	264	308	337	371	413	467	537	635	781	1031	1589
GX4000	190	352	411	449	495	551	622	716	847	1041	1374	2119
GX5000	238	440	514	561	618	688	778	895	1058	1302	1718	2649
GX6000	286	528	617	673	742	826	933	1074	1270	1562	2062	3179

Amperes to 1.80 Final Volts Per Cell @ 25°C (77°F)

BATTERY TYPE	HOURS											
	24	12	10	9	8	7	6	5	4	3	2	1
GX2000	94	174	203	222	245	272	308	354	418	513	674	1023
GX3000	141	261	305	333	367	409	461	531	627	770	1011	1535
GX4000	188	349	407	444	489	545	615	708	836	1026	1347	2046
GX5000	235	436	509	555	611	681	769	885	1045	1283	1684	2558
GX6000	282	523	610	666	734	817	923	1062	1254	1539	2021	3069

ABSOLYTE[®] GX

Absolyte[®] GX Performance Specifications — Constant Current, 1 to 24 hours Amperes to 1.81 Final Volts Per Cell @ 25°C (77°F)

BATTERY TYPE	HOURS											
	24	12	10	9	8	7	6	5	4	3	2	1
GX2000	94	173	202	221	243	270	305	351	414	508	666	1003
GX3000	140	260	303	331	364	406	458	527	622	762	999	1505
GX4000	187	346	404	441	486	541	611	702	829	1016	1331	2006
GX5000	234	433	505	551	607	676	763	878	1036	1270	1664	2508
GX6000	281	519	606	662	729	811	916	1053	1243	1525	1997	3010

Amperes to 1.83 Final Volts Per Cell @ 25°C (77°F)

BATTERY TYPE	HOURS											
	24	12	10	9	8	7	6	5	4	3	2	1
GX2000	92	170	198	216	238	265	299	344	405	496	647	963
GX3000	138	255	298	325	357	398	449	516	608	744	971	1444
GX4000	184	340	397	433	477	530	599	688	811	992	1295	1926
GX5000	230	425	496	541	596	663	748	860	1013	1240	1618	2407
GX6000	276	510	595	649	715	796	898	1032	1216	1488	1942	2889

Amperes to 1.84 Final Volts Per Cell @ 25°C (77°F)

BATTERY TYPE	HOURS											
	24	12	10	9	8	7	6	5	4	3	2	1
GX2000	91	168	196	214	235	262	295	339	400	489	638	941
GX3000	137	252	294	321	353	393	443	509	599	734	957	1412
GX4000	182	336	392	428	470	523	590	678	799	978	1276	1882
GX5000	228	420	490	534	588	654	738	848	999	1223	1595	2353
GX6000	274	504	588	641	706	785	886	1017	1199	1467	1914	2823

Amperes to 1.85 Final Volts Per Cell @ 25°C (77°F)

BATTERY TYPE	HOURS											
	24	12	10	9	8	7	6	5	4	3	2	1
GX2000	90	166	193	211	232	258	291	334	394	481	627	919
GX3000	135	249	290	316	348	387	437	501	590	722	940	1379
GX4000	180	332	387	422	464	516	582	669	787	963	1253	1838
GX5000	225	415	484	527	580	645	728	836	984	1203	1566	2298
GX6000	270	498	580	633	696	775	873	1003	1181	1444	1880	2757

Amperes to 1.86 Final Volts Per Cell @ 25°C (77°F)

BATTERY TYPE	HOURS											
	24	12	10	9	8	7	6	5	4	3	2	1
GX2000	89	163	190	207	228	254	286	328	386	472	615	897
GX3000	133	245	285	311	342	380	429	492	580	709	923	1346
GX4000	178	327	380	415	456	507	572	656	773	945	1230	1795
GX5000	222	408	476	519	570	634	715	820	966	1181	1538	2244
GX6000	267	490	571	622	684	761	858	985	1159	1417	1845	2692

Amperes to 1.88 Final Volts Per Cell @ 25°C (77°F)

BATTERY TYPE	HOURS											
	24	12	10	9	8	7	6	5	4	3	2	1
GX2000	86	157	183	200	220	244	275	316	371	452	586	845
GX3000	128	236	275	300	330	366	413	473	556	678	878	1268
GX4000	171	315	367	400	439	488	550	631	742	905	1171	1691
GX5000	214	393	458	500	549	611	688	789	927	1131	1464	2113
GX6000	257	472	550	599	659	733	825	947	1113	1357	1757	2536

ABSOLYTE[®] GX

Absolyte[®] GX Performance Specifications - Constant Current, 1 to 24 hours Amperes to 1.90 Final Volts Per Cell @ 25°C (77°F)

BATTERY TYPE	HOURS											
	24	12	10	9	8	7	6	5	4	3	2	1
GX2000	81	149	174	190	209	232	262	300	354	431	555	769
GX3000	122	224	261	285	313	348	393	451	530	647	832	1153
GX4000	162	299	348	380	418	464	524	601	707	862	1109	1537
GX5000	203	374	435	475	522	581	654	751	884	1078	1387	1922
GX6000	244	448	522	569	626	697	785	901	1061	1293	1664	2306

Amperes to 1.92 Final Volts Per Cell @ 25°C (77°F)

BATTERY TYPE	HOURS											
	24	12	10	9	8	7	6	5	4	3	2	1
GX2000	76	140	163	178	195	217	245	281	330	403	519	718
GX3000	114	210	244	267	293	326	367	421	495	604	778	1077
GX4000	153	280	326	355	391	434	489	562	661	806	1037	1436
GX5000	191	350	407	444	488	543	612	702	826	1007	1296	1795
GX6000	229	420	489	533	586	652	734	843	991	1208	1556	2154

Amperes to 1.94 Final Volts Per Cell @ 25°C (77°F)

BATTERY TYPE	HOURS											
	24	12	10	9	8	7	6	5	4	3	2	1
GX2000	70	129	151	164	181	201	227	261	307	372	471	622
GX3000	105	194	226	247	271	302	341	391	460	558	706	934
GX4000	140	258	301	329	362	403	454	522	613	744	942	1245
GX5000	175	323	377	411	452	504	568	652	766	930	1177	1556
GX6000	210	387	452	493	543	604	682	782	920	1116	1413	1867

Note: To obtain amps for each GX system — multiply the amps/positive value from table by the number of positive plates.

System	GX2000	GX3000	GX4000	GX5000	GX6000
# of Positive Plates	12	18	24	30	36

ABSOLYTE[®] GX

Absolyte[®] GX Performance Curves - Constant Current, 1 to 24 hours

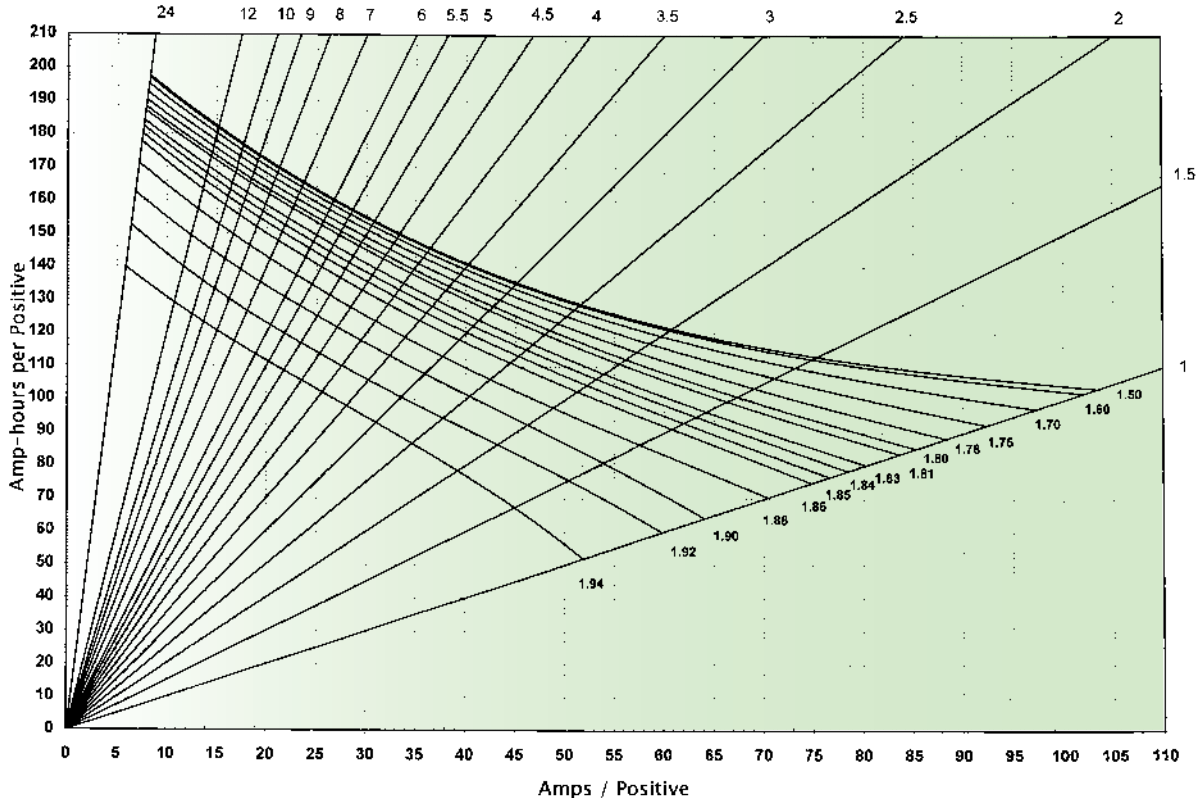

ABSOLYTE® GX

Absolyte® GX Performance Specifications — Constant Current, 36 to 120 hours

Amperes to 1.75 Final Volts Per Cell @ 25°C (77°F)

BATTERY TYPE	HOURS				
	120	100	72	48	36
GX2000	22	26	36	53	70
GX3000	33	39	54	79	104
GX4000	44	52	72	106	139
GX5000	54	65	89	132	174
GX6000	65	78	107	159	209

Amperes to 1.78 Final Volts Per Cell @ 25°C (77°F)

GX2000	22	26	35	52	69
GX3000	32	39	53	78	103
GX4000	43	51	71	104	137
GX5000	54	64	88	131	171
GX6000	65	77	106	157	206

Amperes to 1.80 Final Volts Per Cell @ 25°C (77°F)

GX2000	21	25	35	52	68
GX3000	32	38	52	77	102
GX4000	43	51	70	103	135
GX5000	53	64	87	129	169
GX6000	64	76	105	155	203

Amperes to 1.81 Final Volts Per Cell @ 25°C (77°F)

GX2000	21	25	35	51	67
GX3000	32	38	52	77	101
GX4000	42	50	69	102	134
GX5000	53	63	87	128	168
GX6000	63	76	104	154	202

Amperes to 1.83 Final Volts Per Cell @ 25°C (77°F)

GX2000	21	25	34	50	66
GX3000	31	37	51	75	99
GX4000	42	50	68	100	132
GX5000	52	62	85	126	165
GX6000	62	74	102	151	198

Amperes to 1.84 Final Volts Per Cell @ 25°C (77°F)

GX2000	21	24	34	50	65
GX3000	31	37	50	74	98
GX4000	41	49	67	99	130
GX5000	51	61	84	124	163
GX6000	62	73	101	149	195

ABSOLYTE[®] GX

Absolyte[®] GX Performance Specifications — Constant Current, 36 to 120 hours

Amperes to 1.85 Final Volts Per Cell @ 25°C (77°F)

BATTERY TYPE	HOURS				
	120	100	72	48	36
GX2000	20	24	33	49	64
GX3000	30	36	50	73	96
GX4000	40	48	66	98	129
GX5000	51	60	83	122	161
GX6000	61	72	100	147	193

Amperes to 1.86 Final Volts Per Cell @ 25°C (77°F)

GX2000	20	24	33	48	63
GX3000	30	36	49	72	95
GX4000	40	48	65	96	127
GX5000	50	59	82	121	158
GX6000	60	71	98	145	190

Amperes to 1.88 Final Volts Per Cell @ 25°C (77°F)

GX2000	19	23	31	46	61
GX3000	29	34	47	70	91
GX4000	38	46	63	93	122
GX5000	48	57	78	116	152
GX6000	57	68	94	139	183

Amperes to 1.90 Final Volts Per Cell @ 25°C (77°F)

GX2000	18	22	30	44	58
GX3000	27	32	45	66	87
GX4000	36	43	59	88	116
GX5000	45	54	74	110	145
GX6000	54	65	89	132	173

Amperes to 1.92 Final Volts Per Cell @ 25°C (77°F)

GX2000	17	20	28	41	54
GX3000	25	30	42	62	81
GX4000	34	40	55	82	108
GX5000	42	50	69	103	135
GX6000	50	60	83	123	162

Amperes to 1.94 Final Volts Per Cell @ 25°C (77°F)

GX2000	15	18	25	38	50
GX3000	23	27	38	57	75
GX4000	30	36	51	75	100
GX5000	38	46	63	94	124
GX6000	46	55	76	113	149

ABSOLYTE[®] GX

Absolyte[®] GX Long Duration Discharge Performance, 24 to 120 hours

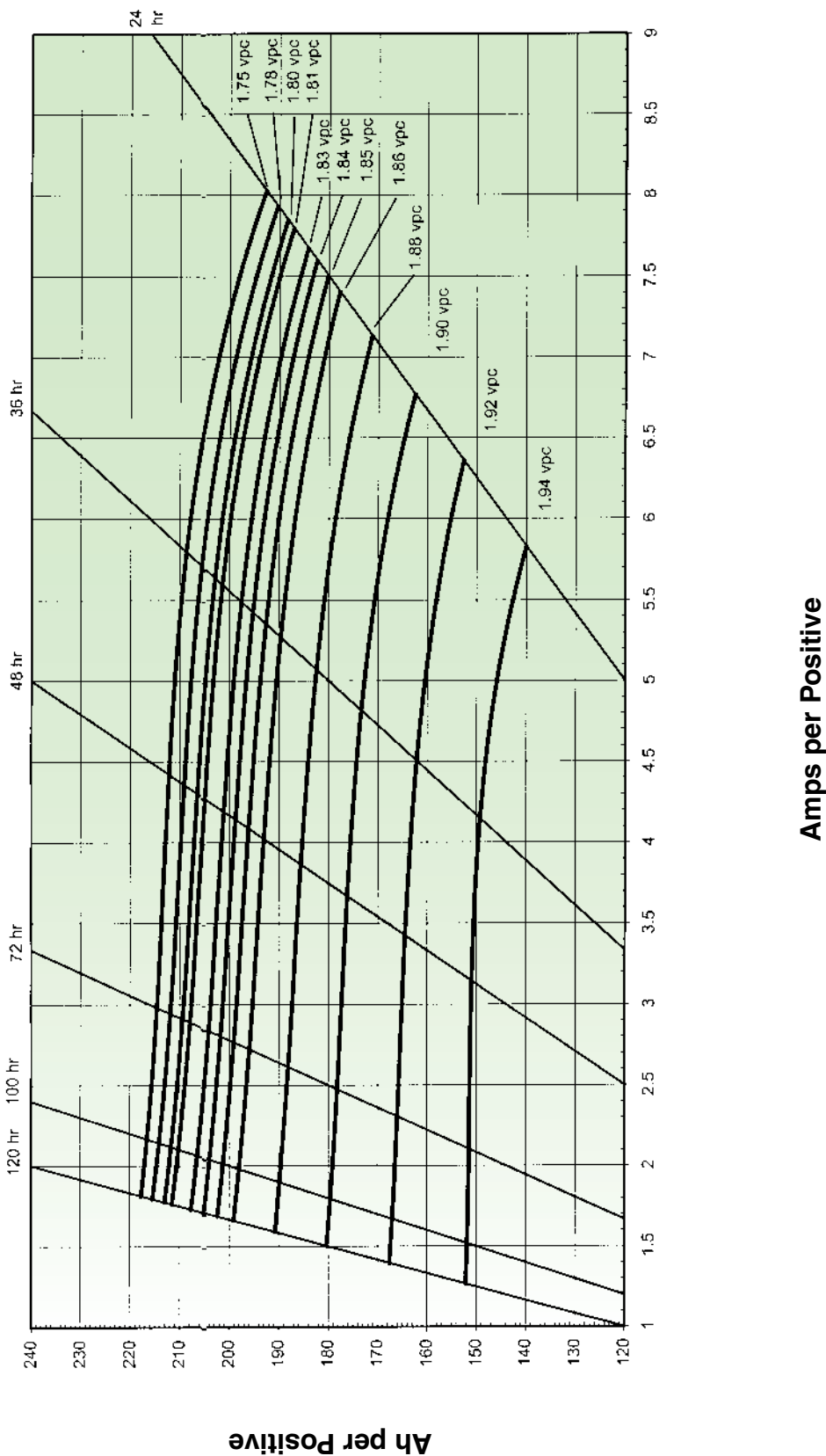

ABSOLYTE[®] GX

Absolyte[®] GX Recharge Characteristics @ 25°C (77°F), 2.24 Volts Per Cell Float

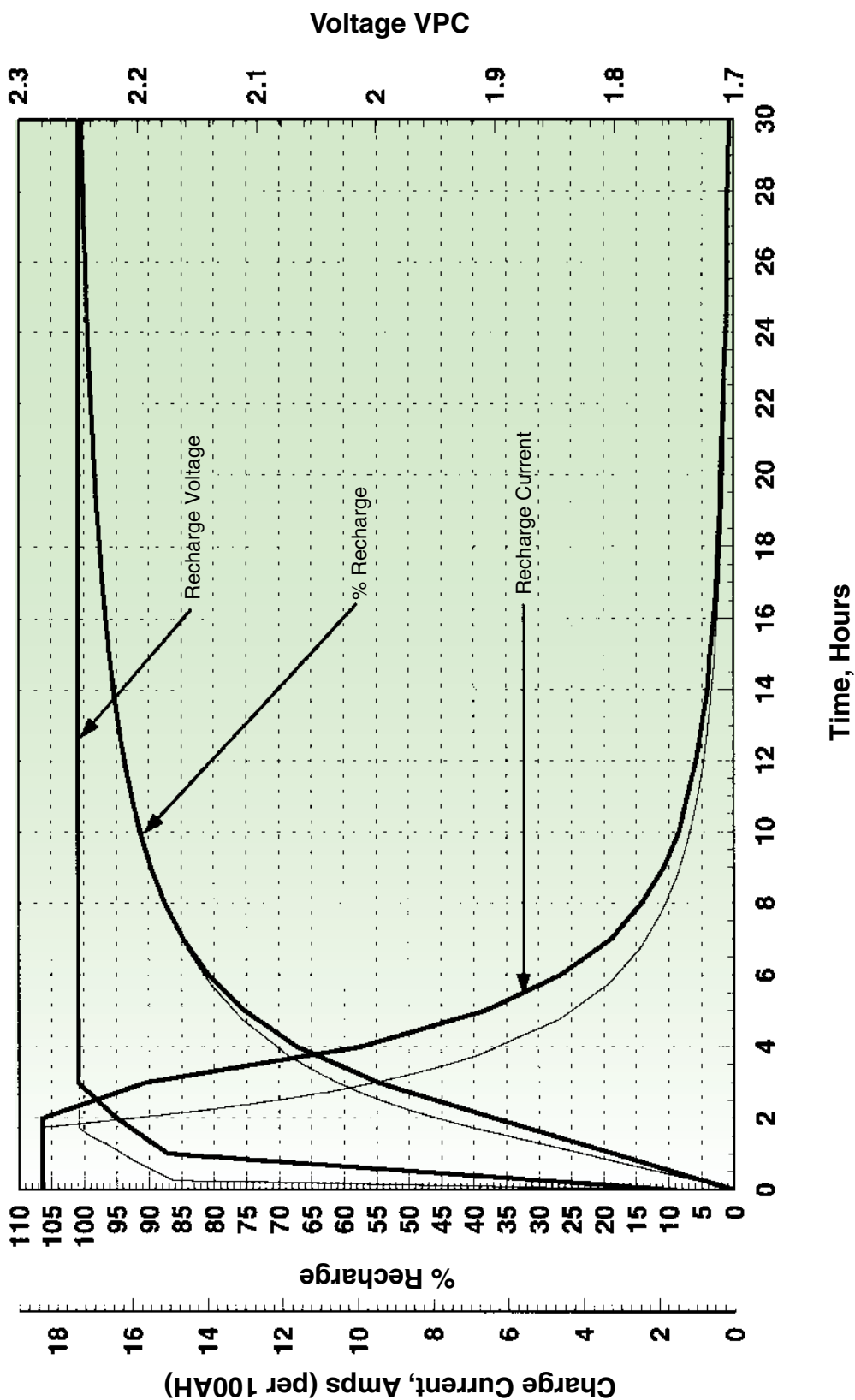

Note: Design and/or specifications are subject to change without notice. If questions arise, contact your local GNB Sales representative for clarification.

GNB Industrial Power – The Industry Leader.



GNB Industrial Power, a division of Exide Technologies, is a global leader in network power applications including communication/data networks, UPS systems for computers and control systems, electrical power generation and distribution systems, as well as a wide range of other industrial standby power applications. With a strong manufacturing base in both North America and Europe and a truly global reach (operations in more than 80 countries) in sales and service, GNB Industrial Power is best positioned to satisfy your back up power needs locally as well as all over the world.

Based on over 100 years of technological innovation the Network Power group leads the industry with the most recognized global brands such as ABSOLYTE®, GNB® FLOODED CLASSIC®, MARATHON®, ONYX®, RELAY GEL®, SONNENSCHNEIN®, and SPRINTER®. They have come to symbolize quality, reliability, performance and excellence in all the markets served.

GNB Industrial Power takes pride in its commitment to a better environment. Its Total Battery Management program, an integrated approach to manufacturing, distributing and recycling of lead acid batteries, has been developed to ensure a safe and responsible life cycle for all of its products.

Contact Us: (866) 324-4410

SECTION 27.20 2012-11

